

**1 panel (VA 5813 P1)**

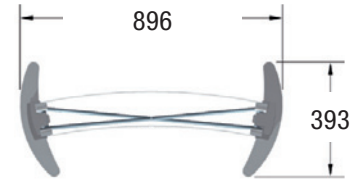

**2 panels (VA 5823 P1)**

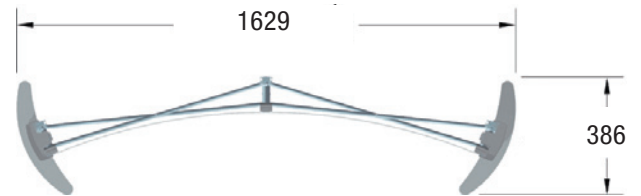

**3 panels (VA 5833 P1)**

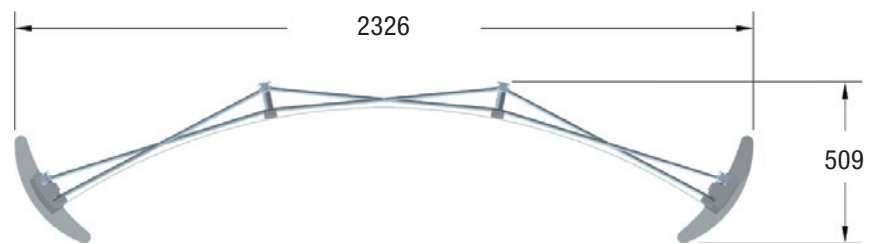

**4 panels (VA 5843 P1)**

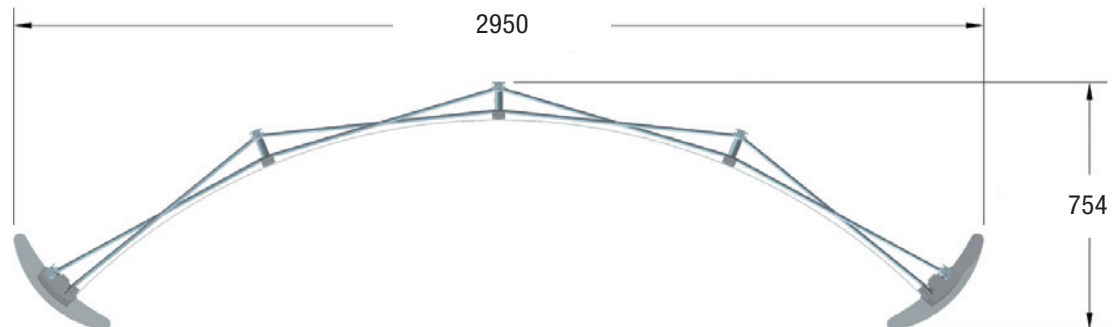

# ACCESSORIES

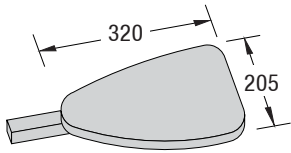

**VA 1213**  
Display shelf  
white

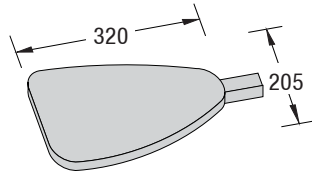

**VA 1214**  
Display shelf  
white

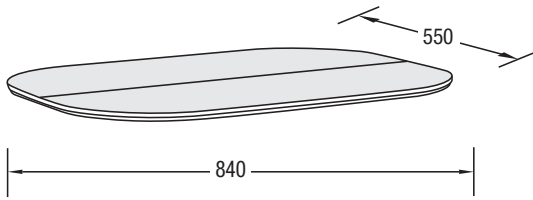

**VA 8069**  
Counter top  
for transport case  
VA 8056, white,  
foldable

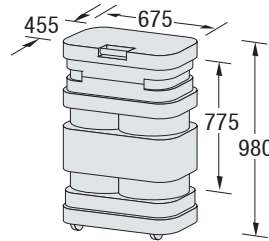

**VA 8056**  
transport  
case

**VA 8079**  
Counter top  
for transport case  
VA 8056, grey,  
foldable

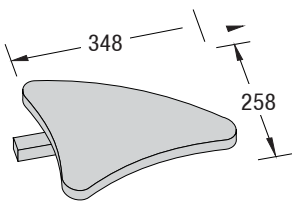
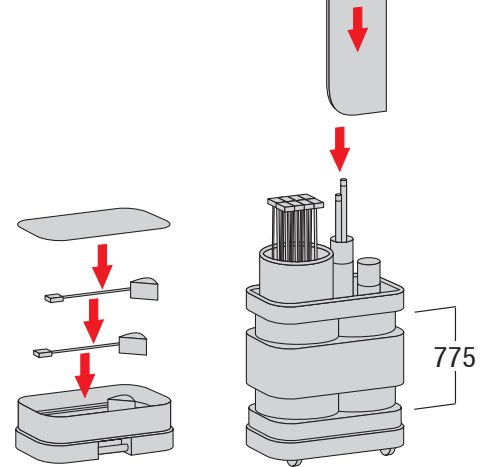

**VA 1216**  
Display shelf  
white

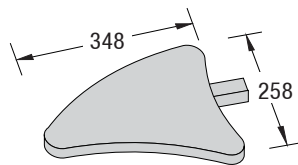

**VA 1217**  
Display shelf  
white

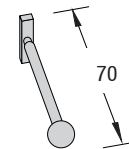

**E 275**  
Bag holder

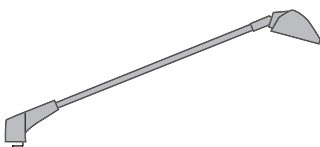

**M 1498**  
Long arm spotlight  
LED, 12 W / 230 V

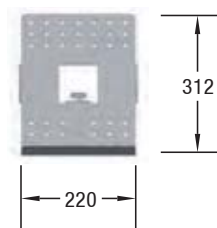

**VA 1240**  
Brochure shelf  
universal